



# Locker Lock M610 L033-A03

## Operating Instructions

<b>Contents</b>	<b>Page</b>
General Description / Technical Specifications / Safety Precautions.....	2
Care and Maintenance / Factory Settings / Functional Description .....	3
Overview of Transponder Cards .....	4
System Components / Package Contents / Installation .....	5
Dimensions .....	7
Getting Started and Changing Batteries / Tips for Programming .....	8
Using the Installation Card / Programming the Master Card .....	9
Programming the User Cards / Closing and Opening .....	10
Unauthorised Transponder Cards / Facility Manager Function / Emergency Opening .....	11
Deleting Individual Transponder Cards / Deleting all Transponder Cards .....	12
Changing the Operating Mode / Deactivating and Activating Acoustic Signals .....	13
Resetting to Factory Settings .....	14
Battery Warning .....	15
Emergency Power Supply / Firmware Update.....	16
Reordering Master Cards /Troubleshooting .....	17

## GENERAL DESCRIPTION

The M610 L033-A03 locking system is an electronic locker lock with a RFID reader. The system is intended for indoor use. Using the system in applications for which it is not intended may result in irreparable damage to it and render any claims null and void. These operating instructions provide information how to properly install and operate the locking system.

Please be sure to observe all warnings and read the operating instructions completely before proceeding with installation, commissioning and programming.

It may be possible to use our locks and locking systems together with mechanisms made by other manufacturers, but their compatibility must be checked in each individual case. We cannot accept any liability for damage or loss due to incompatibility.

Wording and graphics have been prepared with care. However, no liability will be assumed for any mistakes that may have occurred. Technical specifications as well as the scope of items in the system are subject to change without notice.

**CAUTION:** The locking system can be configured with master and programming cards or with the LEHMANN Management Software LMS. These operating instructions describe how to use the locking system with master and programming cards. The software LMS and the corresponding documents can be found at <https://lms.lehmann-locks.com>.

## TECHNICAL SPECIFICATIONS

<b>Frequency</b>	13.56 MHz National legislation about permissible radio frequencies must be observed.
<b>RFID technology</b>	MIFARE® Classic, MIFARE® DESFire EV1, EV2
<b>Supported transponders</b>	Compatible with the following RFID transponder cards: <ul style="list-style-type: none"><li>• MIFARE® Classic (1K / 4K)</li><li>• MIFARE® DESFire</li><li>• cards complying with ISO 14443A</li></ul> Existing transponders must be checked for compatibility. MIFARE® Classic transponders are only supported in „Assigned use“ mode. MIFARE® Classic transponders cannot be used with the LMS. Support of NFC-enabled Android smartphones incl. LEHMANN Transponder App when configured by master card or LEHMANN Management Software LMS 2.x. Firmware vers. 2.x is required in the RFID reader.
<b>Energy supply</b>	2 batteries in the lock (type CR123A)
<b>Operating temperature</b>	-5°C - +60°C
<b>Storage temperature</b>	-25°C - +70°C
<b>Type designation</b>	Locker lock M610: SLIICBM6 External RFID reader L033-A03: L2NF13MX

## SAFETY PRECAUTIONS

- When replacing the batteries, make sure that the polarity and position of the batteries are correct!
- Dispose of used batteries properly!
- Do not heat batteries, take them apart or short-circuit them!

- Never throw batteries into open fire!
- The batteries must not be charged!
- Keep the product away from children, as small parts may be swallowed!
- Any person swallowing batteries must seek immediate medical advice!
- Damaged and/or leaking batteries may cause acid burns and/or poisoning!

## CARE AND MAINTENANCE

- Do not spill any liquid over or into the individual components of the system, and never immerse the components in any liquid.
- The product should not be exposed to direct sunlight.
- Clean the system with a clean, soft, damp cloth only.
- Do not use any cleaning agents containing abrasives or solvents, as these may damage the housing.
- Treating any of the electronic and mechanical components improperly or in any way other than described in these operating instructions may lead to malfunctions and the loss of warranty.

## FACTORY SETTINGS

The system can be closed and opened at this point of time with one or more installation cards. You have the option of changing the operating mode (see Changing the operating mode, P. 13).

## FUNCTIONAL DESCRIPTION

This locking system is a compact, battery-powered furniture lock for different applications in the home and office. Opening and closing are powered by an electric motor. Contactless RFID technology based on 13.56 MHz is used as a “key”.

Two operating modes are available:

Lock operating mode	Description
Assigned use (factory settings)	There is a fixed assignment between the transponder cards and the locks. The user cards are programmed or deactivated at the lock by means of a master card. The system thus allows the granting of selective access authority for an item of furniture (e.g. cabinet), so that only authorised persons with a transponder card have access. A transponder card can be programmed simultaneously on multiple locks with “Assigned use” operating mode. Up to 50 different transponder cards can be programmed per lock.
Shared use	With the user card, a user can use a free lock / storage of his choice. It is not possible to program the user card using the master card. If a lock is closed with the user card, the user card and the furniture lock are coupled to each other. The card cannot be used at any other lock in “shared use” mode, and the lock will not accept any other user card. This coupling is only deactivated when the user opens the lock again with his user card. The card can now be used for another lock.

**Only the M610 L033-A03 with a spacer is suitable for use on metallic surfaces.**

Please note that the distance between two or more RFID readers must be at least 5 cm.

This system is not intended for „push-to-open“ applications. If required, this needs to be tested on individual basis.

## OVERVIEW OF TRANSPONDER CARDS

Card type	Description
Installation card (only for assembly and testing purposes)	The installation card can be used specially for assembly and testing purposes in order to perform basic functions on the lock (opening and closing). Furthermore, the lock can be closed using the installation card for transporting the furniture to its destination. This card is for universal use. Any number of installation cards can be used at any lock. Prior programming of a master card is not necessary. After a master card has been programmed for the first time, the lock is disabled for the installation card. The use of an installation card is optional.
Master card	For complete commissioning, a master card must be programmed for both operating modes. The master card is required for starting and terminating programming operations. This also includes the programming of user cards in "Assigned use" mode. The master card also enables the so-called Facility Manager function and the emergency opening of the lock. A maximum of <u>one</u> master card can be programmed per lock. You can use one master card for several locks.
User card	User cards are used to open and close the lock. In "Assigned use" mode, up to 50 user cards can be programmed on one lock. In "Shared use" mode, <u>one</u> user card can be used temporarily on one lock. It is possible to program one user card on several locks in "Assigned use" mode, and at the same time on one lock in "Shared use" mode.
Programming card set	For certain programming functions, programming cards are required in conjunction with the master card. The programming card set consists of 3 universal programming cards: <ul style="list-style-type: none"> <li>• P1: Mode (change of mode)</li> <li>• P2: Sound (activating or deactivating acoustic signals)</li> <li>• P3: Reset (reset to factory settings)</li> </ul>
Update card	In addition to the master card, you will receive an update card. In conjunction with the master card, the update card allows firmware updates to be loaded into this locking system.
Service key	In addition to the master card and update card, you will receive a card with an individual service key. Please keep the card with the service key carefully and securely. The printed service key allows you to reorder master cards. It is <u>not</u> possible to reorder a master card without a service key! This card has no electronic function!

As user cards, you can either use LEHMANN user cards or cards of a third-party provider complying with ISO 14443A. Please note the following possible restrictions when using user cards of third-party providers:

- The comprehensive security concept, which was specially designed for this locking system in conjunction with the user cards of LEHMANN Vertriebsgesellschaft mbH & Co. KG, may be affected by the use of user cards of a third-party provider.
- The "Shared use" operating mode is only possible with user cards from third-party providers if they have the appropriate write permission for the user card.
- Transponder cards with a so-called "Random-UID" are not supported.

Transponders from third-party providers must be checked for compatibility in advance. For the highest possible level of safety, transponder cards based on MIFARE® DESFire are recommended.

MIFARE® Classic transponders are of limited use (only in „assigned use“ mode, not with LMS).

Please note that installation cards, master cards, user cards and programming cards must be ordered separately.

**Please keep the master and update cards as well as the card with the individual service key carefully and securely!**

## M610 with external RFID reader L033-A03

Please note, that these operating instructions apply to different product versions. Therefore the packaging content depends on the respective product variant. The product variants and mounting recommendations shown here are intended for wooden furniture with a thickness of 19mm. In the case of deviating thicknesses or materials, the screws for mounting the lock and the RFID reader must be adapted.

### Components for M610

1. M610
2. 4x screw (4,5x16) for M610
3. 2x battery CR123A
4. Cover for M610
5. Striker plate
6. 3 x flat headed screw (3,0 x 15 mm) for striker plate, only included in single-set packaging
7. Pin for battery compartment

### Components for RFID reader L033-A03

8. Cabel
9. RFID reader L033-A03
10. 2x thermoplastic screw (3x20)
11. Spacer
12. 2x thermoplastic screw (3x25) for mounting the spacer and the RFID reader L033-A03

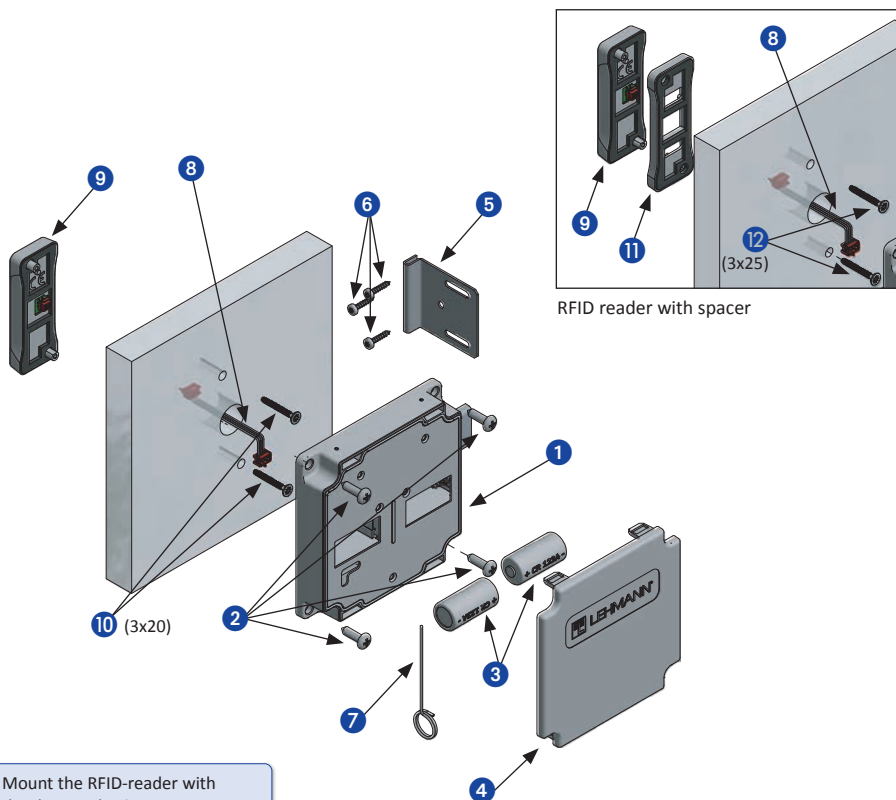

RFID reader with spacer

Mount the RFID-reader with the thermoplastic screws 3x20.  
Use the thermoplastic screws 3x25 ONLY for the RFID reader with spacer.

Please note the different mounting positions and drilling pattern for the RFID readers.

M610

RFID reader L033-A03  
**without** spacer

RFID reader L033-A03  
**with** spacer

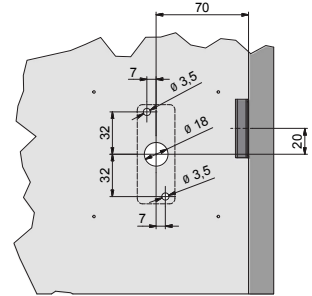
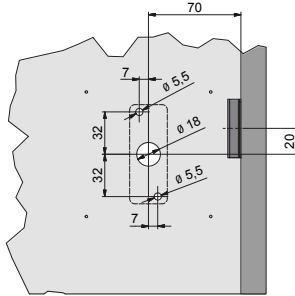
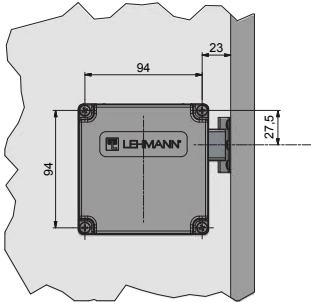

- CAUTION:**
- For mounting the RFID reader L033-A03
    - **without** spacer please use drill holes of 5,5mm.
    - **with** spacer please use drill holes of 3,5mm.
  - Please countersink holes for screwheads for mounting the RFID reader.

**Installation instructions:**

- Do not use countersunk head screws when installing the locker lock.
- Flat headed screws (3,0 x 15) are recommended for mounting the striker plate (only included in single-set packaging).
- When installing the RFID reader on wooden and HPL doors, the screw heads must be sunk completely in the door.
- A splash water and dust protection can only be ensured if the lock and the RFID reader lie completely on the door surface (except Omega-profiles).
- The locker lock M610 is available in two versions (right or left mounting).
- Please ensure the correct installation position of the lock and the RFID reader.
- Tighten the screws hand-tight with max. 0.7 Nm.

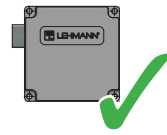
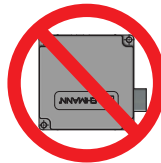
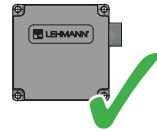
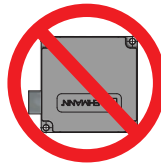

# DIMENSIONS

M610

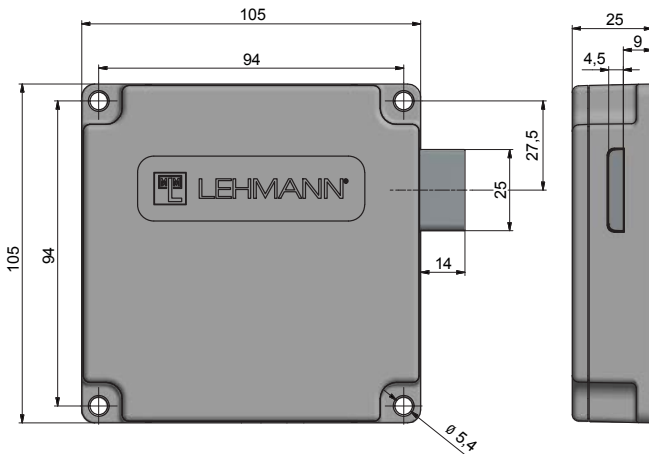

RFID reader L033-A03

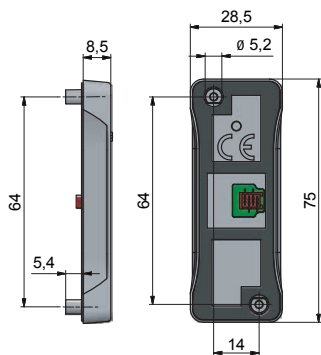

RFID reader L033-A03  
with spacer

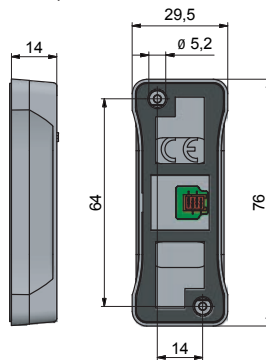

Striker plate

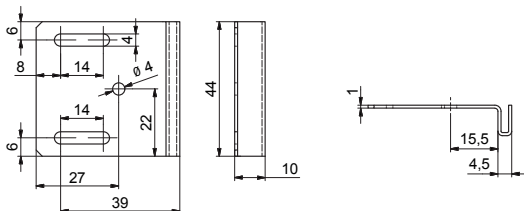

## GETTING STARTED AND CHANGING BATTERIES

Please make sure the lock and the RFID reader are properly connected by using the connection cable. Make sure that the connections between the plugs and the sockets are properly aligned.

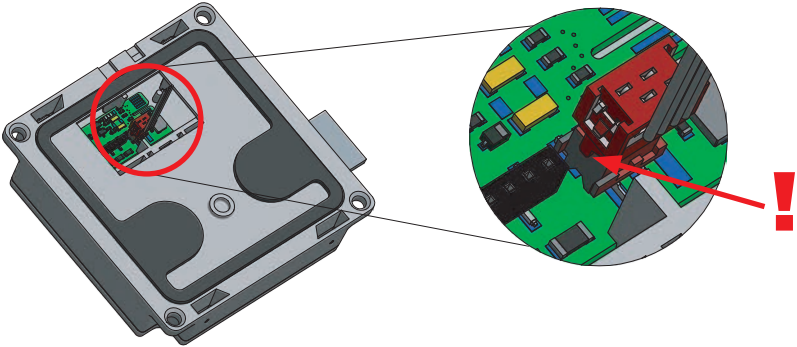

**CAUTION:** Use only CR123A primary-batteries.

Open the battery compartment cover by inserting the pin into the small holes and releasing the cover. Lift the cover off at the same time. Insert the batteries CR123A in the battery compartment. Use only CR123A primary-batteries.

Make sure that the batteries are correctly inserted in the battery compartment and wait until a long acoustic signal and at the same time an optical signal (yellow) are given.

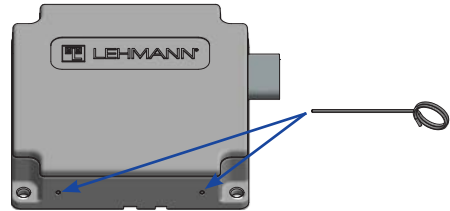

**Inserting the batteries**

Batteries are inserted correctly in the battery compartment.



Close the cover of the battery compartment. Press the cover until it snaps into all four latch positions. Then program the lock in accordance with these operating instructions.

## TIPS FOR THE FOLLOWING PROGRAMMING STEPS

The last 5 seconds before the shutdown of the programming process are announced by the flashing of a yellow lamp and acoustic signals. The visual and acoustic signals are differentiated as follows.

**Optical signals**

- Short flashing
- Long flashing

**Acoustic signals**

- Short
- Long



## USING THE INSTALLATION CARD (optional)

During installation, one or more installation cards can be used. The installation cards are ready for immediate use and do not have to be programmed. With the installation cards, the basic functions (opening and closing) can be carried out on the lock. It is not possible to program user cards with the installation card. The installation card can no longer be used on a lock as soon as the master card has been programmed.

### Closing

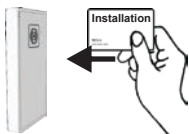

Hold the installation card in front of the reader.



### Opening

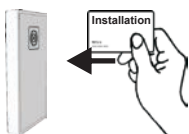

Hold the installation card in front of the reader.



## PROGRAMMING THE MASTER CARD

Irrespective of the desired operating mode, a master card must always be programmed before further programming and operation. Only one master card can be programmed per lock! The programming of the master card can be carried out when the lock is closed as well as when it is open. If the lock is closed after the master card has been programmed, the next step must be an emergency opening (see Emergency opening, P. 11).

### Programming the master card for the first time

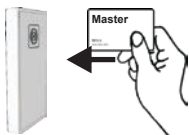

Hold the master card in front of the reader.







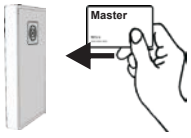

## OPERATING MODE

The locking system is in „assigned use“ mode after the master card has been programmed. If you would like to use the lock in “Shared use“ mode, the next thing to do is to change the operating mode. To do this, please follow the instructions on page 12 and then continue with the section “Closing and Opening“ on page 10.

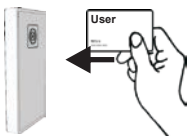

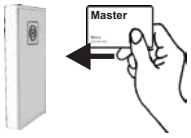

## PROGRAMMING THE USER CARDS (only for "Assigned use" mode)

In "Assigned use" mode, a maximum of 50 different user cards can be programmed per lock. It is not possible to program user cards in "Shared use" mode. In "Shared use" mode, the lock can be opened and closed without first programming the user cards (see Closing and Opening, P. 10).

Programming user cards	
 <p>Hold the master card in front of the reader.</p>	
 <p>Hold the user card in front of the reader. The card is accepted and programmed. This process can be repeated to program multiple user cards.</p> <p>Card is not accepted.</p>	 
 <p>Hold the master card in front of the reader.</p>	

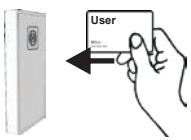
After programming, the user cards can open and close the lock.

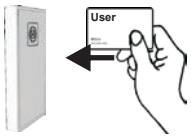
## CLOSING AND OPENING

<p><b>Closing</b></p>  <p>Hold the user card in front of the reader.</p>	
<p><b>Opening</b></p>  <p>Hold the user card in front of the reader.</p>	

## UNAUTHORISED TRANSPONDER CARDS

### Rejection of an unauthorised user card

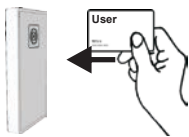

Unauthorised user card is held in front of the reader. The card is rejected.



## FACILITY MANAGER FUNCTION

In the event that an authorised person only briefly wants to check whether for example a cabinet is actually occupied, the lock can be opened with the master card. With this function, the lock opens for 30 seconds and then closes automatically. After this automatic closure, authorised user cards can continue to be used in “Shared use” mode as well as in “Assigned use” mode.

### Facility Manager Function (lock closes automatically after 30 seconds)

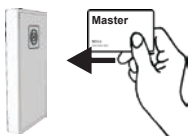

Hold the master card in front of the reader.



## EMERGENCY OPENING

In the event that one or all authorised user cards are currently not available, an emergency opening can be effected with the master card. Please note that the lock remains open after emergency opening. In the “Shared use” mode, the previously used user card is blocked after emergency opening, and can no longer be used. In “Assigned use” mode, user cards that have been programmed can continue to be used normally.

### Emergency opening

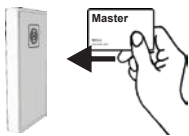

Hold the master card in front of the reader.

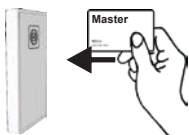







Hold the master card in front of the reader.

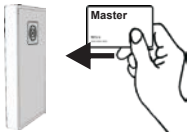

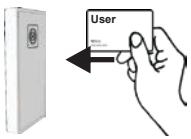
## DELETING INDIVIDUAL TRANSPONDER CARDS (only for "Assigned use" mode)

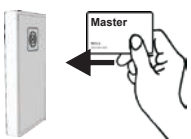

Insofar as further user cards were programmed on the lock, these can continue to be used on this lock after an individual user card has been deleted. For the deleting process, the lock must be open. To do this, first carry out an emergency opening with the master card if necessary (see Emergency opening, P. 11).



Deleting individual user cards	
 <p>Hold the master card in front of the reader</p>	
 <p>Hold the user card to be deleted in front of the reader.</p>	
 <p>Hold the master card in front of the reader.</p>	

Should the user card be lost, then please proceed as follows.

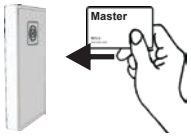
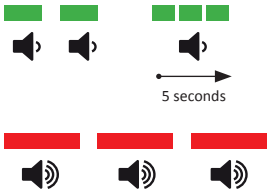
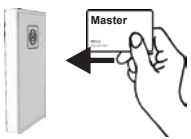
## DELETING ALL TRANSPONDER CARDS (only for "Assigned use" mode)

The deleting process can only be carried out when the lock is open. Should there be no authorised user card to hand, first perform an emergency opening using the master card.

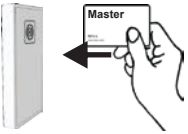





Deleting all user cards	
 <p><b>IMPORTANT:</b> Hold the master card in front of the reader until all the following optical and acoustic signals have been received.</p>	
 <p><b>IMPORTANT:</b> Hold the master card in front of the reader until all the following optical and acoustic signals have been received.</p>	

 <p>Hold the master card in front of the reader.</p>	
---	---

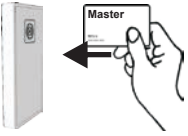
## CHANGING THE OPERATING MODE

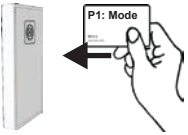
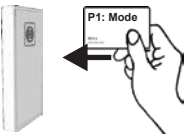
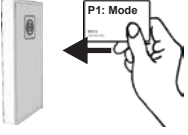
The lock has two modes: “Assigned use” and “Shared use”.

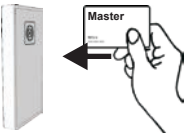
When the lock is open, you have the option of changing the mode. To do this, the master card and the programming card No. 1 (P1: Mode) are required. The programming card set must be bought separately from LEHMANN Vertriebsgesellschaft mbH & Co. KG. The cards are for universal use.

Changing the operating mode		
 <p>Hold the master card in front of the reader.</p>		
 <p>Hold the programming card No. 1 (P1: Mode) in front of the reader. “Shared use” mode is selected.</p>	<p>Shared use</p> 	
 <p>Hold the programming card No. 1 (P1: Mode) in front of the reader again. “Assigned use” mode is selected.</p>	<p>Assigned use</p> 	
 <p>Hold the master card in front of the reader.</p>		







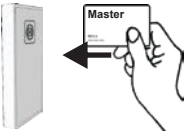

## DEACTIVATING AND ACTIVATING ACOUSTIC SIGNALS

Acoustic signalling is activated when the system is delivered. You have the option of deactivating the acoustic signals with the aid of the master card and the programming card No. 2 (P2: Sound). For this, the lock must be open. It is recommended that the acoustic signals should only be deactivated if the RFID reader with the LED is mounted outside the item of furniture. Otherwise, neither visual nor acoustic signals are passed on to the users, making programming and possibly also operation difficult.

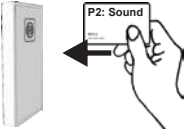
continue on page 14

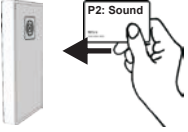
Please note that the acoustic signals for the battery warning and for changing the operating mode cannot be deactivated.

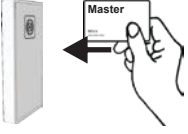

The programming card set must be bought separately from LEHMANN Vertriebsgesellschaft mbH & Co. KG. The cards are for universal use.





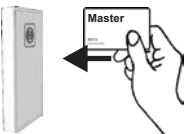

Deactivating and activating acoustic signals	
 <p>Hold the master card in front of the reader.</p>	
 <p>Hold the programming card No. 2 (P2: Sound) in front of the reader. The acoustic signals are deactivated.</p>	<p>Acoustic signals are deactivated.</p> 
 <p>Hold the programming card No. 2 (P2: Sound) in front of the reader again. Acoustic signals are activated again.</p>	<p>Acoustic signals are activated.</p> 
 <p>Hold the master card in front of the reader.</p>	

## RESETTING TO FACTORY SETTINGS (RESET)

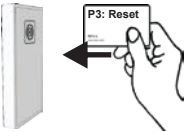
If a reset to factory settings is required, all master and user cards are deleted. With an installation card the basic functions (close and open) can be carried out. The bolt is retracted, and the lock must be reprogrammed with a master card.

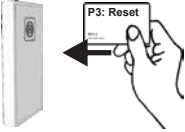
The reset function can be used with the help of the master card and programming card No. 3 (P3: Reset). For this, the lock must be open. The programming card set must be bought separately from LEHMANN Vertriebsgesellschaft mbH & Co. KG. The cards are for universal use.

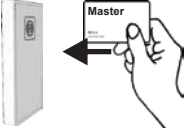
Resetting to factory settings	
 <p>Hold the master card in front of the reader.</p>	

 <p>Hold the programming card No. 3 (P3: Reset) in front of the reader.</p>	
 <p>Hold the programming card No. 3 (P3: Reset) in front of the reader again.</p>	
 <p>Hold the master card in front of the reader.</p>	 <p>(after about 10 seconds)</p>

## BATTERY WARNING

The locking system is equipped with a battery management system which uses visual and acoustic signals to indicate the need for battery replacement in the event of reduced battery power. The battery warning takes place in two phases:

<p><b>Battery warning Phase 1</b></p> <p>Before an action can be carried out (closing / opening / programming), a battery warning is given. The batteries should be replaced. The battery warning is also given every 60 minutes.</p>	
<p><b>Battery warning Phase 2</b></p> <p>The lock can only be opened. Before the lock opens, a battery warning is given. The batteries must be replaced without delay. The battery warning is also given every 60 minutes.</p>	

The settings are saved even without a power supply (e.g. in case of battery replacement, or in case the batteries should be completely empty). Battery replacement should be carried out within 5 minutes.

## EMERGENCY POWER SUPPLY

If the batteries are completely discharged and you cannot reach the battery compartment inside the furniture, you still have the option of obtaining an emergency power supply if you have an external RFID reader. To do this, you can use a standard power bank (additional rechargeable battery) with a USB port complying with the USB 2.0 standard. A micro USB Type B connector is required for the emergency power supply of the RFID reader. Use the emergency power supply only for a short period of time for the one-off opening of a lock. Before use, it is essential that you should read the operating instructions of the power bank. Please proceed as follows:

- First remove the protective rubber cap on the micro USB port on the underside of the RFID reader.
- Connect the charged power bank to the RFID reader using the micro USB port.
- Please take account of the operating instructions of the power bank, e.g. for starting and ending the charging process.
- Please do not perform any further actions until the RFID reader gives an acoustic and a visual signal (see Acoustic and visual signals when inserting the batteries).
- Then open the lock with an authorised transponder card. Here you can use either a programmed user card or the master card for emergency opening.
- Then carefully disconnect the power bank from the RFID reader.
- Replace the protective rubber cap on the micro-USB port of the RFID reader.
- Replace the batteries in the lock (see Getting started and changing batteries).
- Perform a function test (opening and closing) while the furniture is open.

RFID reader L033-A03



Micro USB port for external power supply and firmware updates

## FIRMWARE UPDATE

You have the option of updating the firmware of the lock and the RFID reader via the micro USB ports on the lock or the RFID reader. Firmware updates are provided only when needed (for example, technical need). To update the firmware you need the software LEHMANN Firmware Updater. The software can be found on the website [www.lehmann-locks.com](http://www.lehmann-locks.com) under Electronic Locking Systems and there under Software Solutions. The individual steps for updating the firmware are described in the software.



## REORDERING MASTER CARDS







With this locking system, you have the option of ordering replacements for your master cards at your own expense. For this you obtained a service key together with the master cards. Please keep the service key carefully and securely. The service key makes it possible to reorder the master card specified there.

To reorder these cards, please contact LEHMANN Vertriebsgesellschaft mbH & Co. KG at the following email address: [sales@lehmann-locks.com](mailto:sales@lehmann-locks.com)

In your email, please give us your contact data and the service key. In your email, please also state the number of replacement cards you require.

## TROUBLESHOOTING

In the following overview you can see the acoustic and visual signals that indicate faults:

	<p>Transponder card cannot be programmed.</p>	<p>Possible reasons:</p> <ul style="list-style-type: none"> <li>• Storage space is used up</li> <li>• Card is not compatible</li> <li>• Master card has not yet been programmed</li> </ul>
	<p>Available storage space in the lock is used up.</p>	<p>Possible reasons:</p> <ul style="list-style-type: none"> <li>• 50 user cards have already been programmed in the lock.</li> </ul>
	<p>Bolt warning: the bolt does not move to the end position.</p>	<p>Possible reasons:</p> <ul style="list-style-type: none"> <li>• Striker plate or lock not correctly installed.</li> <li>• Furniture door is not closed.</li> <li>• It is being blocked by an object.</li> </ul>
	<p>Battery warning Phase 1</p>	<p>It is recommended that you replace the batteries.</p>
	<p>Battery warning Phase 2</p>	<p>The batteries must be replaced without delay.</p>
	<p>Communication error between the RFID reader and the lock</p>	<p>Possible reason:</p> <ul style="list-style-type: none"> <li>• Connecting cable between the lock and the RFID reader is not correctly connected.</li> </ul>

For further recommendations on how to eliminate possible faults, you can also refer to the following table:

<p>Reading range is low</p>	<ul style="list-style-type: none"> <li>• Move the transponder card slowly and directly centred in front of the RFID reader.</li> <li>• Check and if necessary replace the batteries.</li> <li>• Test the reading range with the supplied master card.</li> <li>• Test the reading range with a second user card.</li> </ul>
<p>Lock does not respond to user card</p>	<ul style="list-style-type: none"> <li>• Check whether the lock reacts to the supplied master card (if necessary, follow the programming process for master cards).</li> <li>• Program a new and suitable user card according to the operating instructions.</li> <li>• If necessary, perform an emergency opening in accordance with the operating instructions and check the functions (open/close) with an authorised user card again when the furniture is open. If the lock should work properly, please check to see if the bolt can extend correctly when the furniture is closed (see installation recommendation).</li> <li>• If you are using an existing user card (not from the Lehmann company), check to see whether the appropriate write permission has been given for the transponder card.</li> </ul>
<p>Lock and reader do not react</p>	<ul style="list-style-type: none"> <li>• Check that the batteries have been inserted correctly.</li> <li>• Check to see whether the reader is correctly connected to the lock.</li> <li>• Use the supplied master card and follow the operating instructions for programming the master card.</li> </ul>
<p>Only one user card can be programmed</p>	<ul style="list-style-type: none"> <li>• Check the selected operating mode and change it if necessary to “Assigned use”.</li> </ul>
<p>Only one master card can be programmed</p>	<ul style="list-style-type: none"> <li>• This is correct and is an integral part of the safety concept. You have the option of choosing a replacement master card.</li> </ul>



**LEHMANN Vertriebsgesellschaft mbH & Co. KG**  
Postfach 26 20 • D-32383 Minden  
Fon +49 571/50 599-0 • Fax +49 571/50 599-822  
info@lehmann-locks.com • www.lehmann-locks.com  
DIN EN ISO 9001:2008 zertifiziert