



Locker lock M610 with keypad (M610 TA03 / M610 TA03 pro)

Operating Instructions

Content

Page

General system description / Operating description.....	2
Safety precautions / Care & maintenance / Technical specifications	3
System components & package contents.....	4
Dimensions.....	5
Getting started & changing batteries / Emergency power supply.....	6
Installing the locking system.....	7
Structure of the keypad TA03 / Bolt end position scan function.....	9
Factory settings / Opening & closing in Free Code mode.....	10
Switching to Fixed Code mode / Opening and closing in Fixed Code mode.....	11
User changes the Fixed Code / Switching to Free Code mode	12
Changing the master code.....	13
Changing the emergency opening code.....	14
Emergency opening / Reset to factory settings.....	15
Automatic locking in Fixed Code mode... ..	16
Automatic opening in Free Code mode.....	17
Activation and deactivation of acoustic signals / Configuration of M610 TA03 pro with NFC-App	18
Battery warning.....	19
Firmware update / Disposal	20

GENERAL SYSTEM DESCRIPTION

The M610 TA03 / M610 TA03 pro (keypad) locking system is a locker lock with a motor-driven locking bolt intended for use in the home and office. The lock M610 TA03 pro can be configured either manually or with the LEHMANN Config app on a smartphone. This manual gives you information in order to install and operate the locking system correctly. Keep the operating instructions in an easily accessible place. Using the locking system in applications for which it is not intended may result in irreparable damage to it and render any claims null and void.

Wording and graphics have been prepared for you with care. However, no liability will be assumed for any mistakes that may have occurred. The scope of items included by the manufacturer in the system as well as technical specifications are subject to change without notice.

These instructions must not be reproduced in any way (print, photocopy, etc.) either in whole or in part without written consent from LEHMANN Vertriebsgesellschaft mbH & Co. KG.

OPERATING DESCRIPTION

The electronic locking system provides you with a convenient means of locking and unlocking your locker electronically. The system has two operating modes.

Operating mode 1: Free Code

The user selects his own individual code (3 to 10 digits) for opening and closing the lock. In this mode, the code memory is deleted again as soon as the user opens his locker. This means that the next user can select his new individual code.

Operating mode 2: Fixed Code

The user can only open and close the lock with a fixed preset code (3 to 10 digits).

IMPORTANT: Only install the locking system when it is unlocked. For the correct mechanical connection of the locking system to your locker, please refer to the installation instructions of your locker manufacturer. Perform all programming operations and functional checks when the locker door is open. In the event of a malfunction, you thus have access to all system components.

FCC Compliance Statement

This device complies with part 15 of the FCC Rules. Operation is subject to the following two conditions: (1) This device may not cause harmful interference, and (2) this device must accept any interference received, including interference that may cause undesired operation.

Caution!

Changes or modifications not expressly approved by the party responsible for compliance could void the user's authority to operate the equipment.

Note: This equipment has been tested and found to comply with the limits for a Class B digital device, pursuant to part 15 of the FCC Rules. These limits are deigned to provide reasonable protection against harmful interference in a residential installation.

This equipment generates, uses and can radiate radio frequency energy and, if not installed and used in accordance with the instructions, may cause harmful interference to radio communications. However, there is no guarantee that interference will not occur in a particular installation. If this equipment does cause harmful interference to radio or television reception, which can be determined by turning the equipment off and on, the user is encouraged to try to correct the interference by one or more of the following measures:

- Reorient or relocate the receiving antenna.
- Increase the separation between the equipment and receiver.
- Connect the equipment into an outlet on a circuit different from that to which the receiver is connected.
- Consult the dealer or an experienced radio/TV technician for help.



SAFETY PRECAUTIONS

- Pack the batteries to transport the lock in such a way, that no short circuit can occur (explosion and fire hazard).
- On changing the batteries, ensure correct battery polarity and position.
- Dispose of spent batteries and packaging material in the proper manner (see page 20, „Disposal“).
- Do not heat batteries, take them apart or short-circuit them.
- Never throw batteries into open fires.
- The batteries must not be charged.
- Keep the batteries and packaging material out of children’s reach.
- Any person swallowing batteries must seek immediate medical advice.
- Damaged or leaking batteries may cause acid burns and/or poisoning.

CARE AND MAINTENANCE

- Protect all system components from moisture.
- Clean the locking system with a clean, soft, damp cloth only.
- Do not use any aggressive detergents containing abrasives or solvents. Glass cleaners, thinners, alcohol, benzene or liquids containing ammonia are not suitable for cleaning purposes.
- Treating any of the electronic and mechanical components improperly or in any way other than described in this user manual may lead to malfunctions.
- Replace the batteries in good time, but at the latest when the visual battery warning on the keypad lights up.

TECHNICAL SPECIFICATIONS

Power supply	Battery type: 2 x CR123A
Operating temperature	-5 °C to +60 °C
Storage temperature	-25 °C to +70 °C
Type designation	Locker Lock M610: SLI2CBM6 Locker Lock M610 pro: SLI2CPM6 Keypad TA03: MAIIC3M6

SYSTEM COMPONENTS / PACKAGE CONTENTS

Please note that these operating instructions apply to different product variants. The packaging content therefore depends on the respective product variant. The product variants and installation recommendations shown here are intended for furniture with a wood thickness of 19 mm. For different wood thicknesses and materials, the screws for fixing the lock and the keypad must be adjusted.

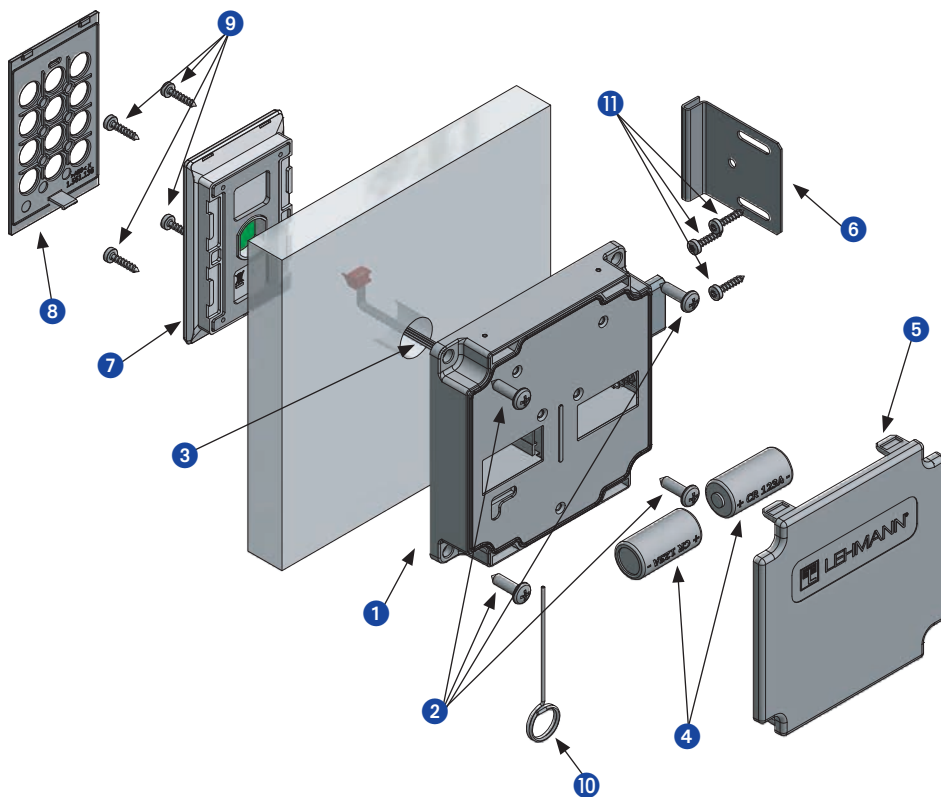

Components:

1. Locker Lock M610 / M610 pro
2. 4 x pan-head screw (4,5 x 16 mm)
3. Cable
4. 2 x battery (CR123A)
5. Battery cover for M610 / M610 pro
6. Striker plate 4516
7. Keypad TA03
8. Cover of keypad TA03
9. 4 x flat headed screw (3,0 x 15 mm)
10. Pin
11. 3 x flat headed screw (3,0 x 15 mm) for striker plate, only included in single-set packaging

DIMENSIONS

Locker lock M610 / M610 pro

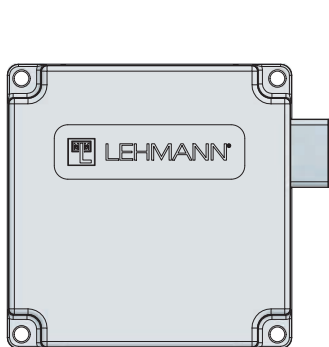

(M610 / M610 pro for right hand doors)

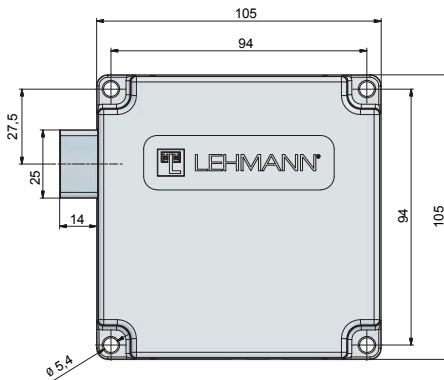

(M610 / M610 pro for left hand doors)

Striker plate 4516

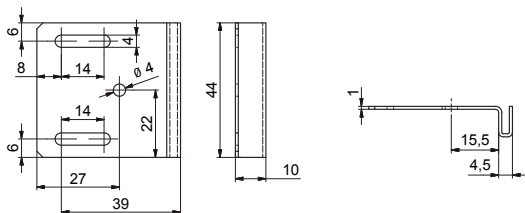

Keypad TA03 without labeling clip

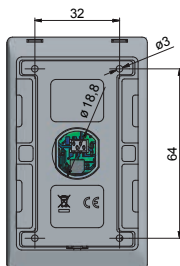
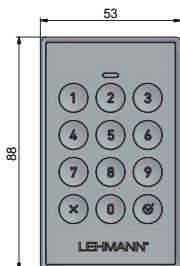

For $\varnothing 19 \times 16$

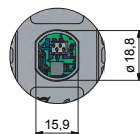

GETTING STARTED / CHANGING BATTERIES

Make sure that the lock and keypad are correctly connected to each other by the connection cable. Pay attention to the correct connection of the plugs and sockets.

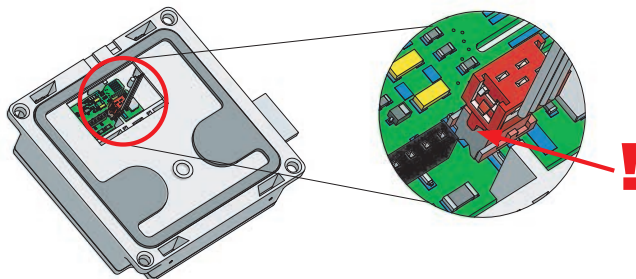

IMPORTANT: Only use two CR123A primary batteries!

Open the battery compartment cover by inserting the pin into the small holes and releasing the cover. Lift the cover off at the same time. Insert the batteries CR123A in the battery compartment. Make sure that the batteries are correctly inserted in the battery compartment. Close the cover of the battery compartment. Press the cover until it snaps into all four latch positions.

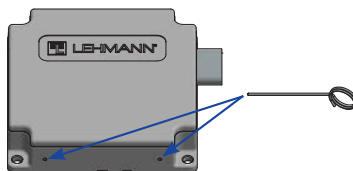

EMERGENCY POWER SUPPLY

The locking system has the option of an emergency power supply in case of empty batteries.

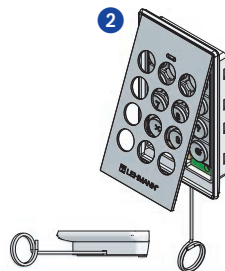
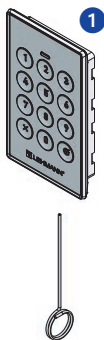

Insert the pin into the hole on the bottom side and press until the cover is released. Then lift up the cover.

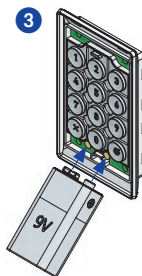

Hold a 9V battery to the contacts at the keypad while entering the code or emergency opening code for opening the lock. Pay attention to the correct polarity of battery!

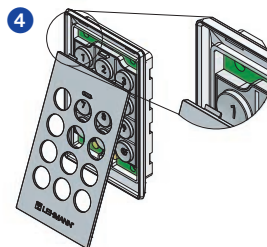

Insert the two guide lugs of the cover into the recesses. Press the cover until it clicks into place.

INSTALLING THE LOCKING SYSTEM

Mounting position of lock M610 / M610 pro

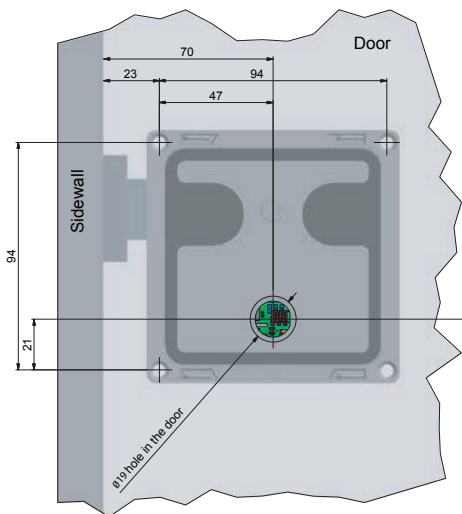

Mounting position of keypad TA03

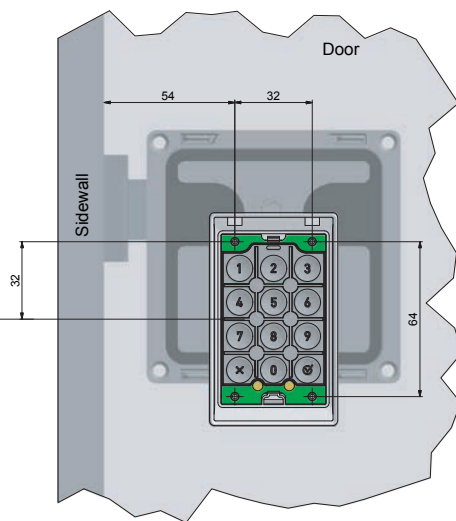

Exemplary for a right door.

Mounting position of striker plate 4516

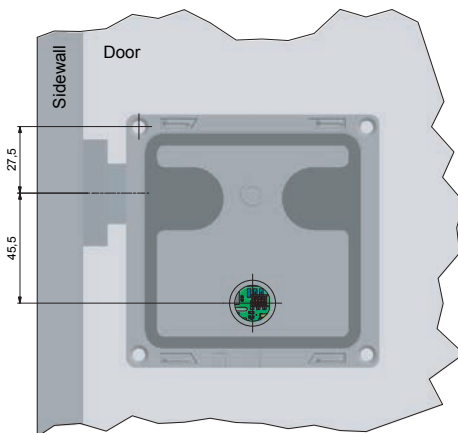
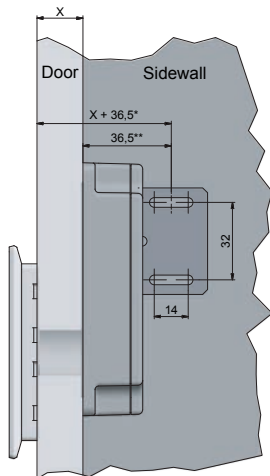

Inlay doors *

Overlay doors **

X = Door thickness

In order to attach the cover to the already mounted keypad unit TA03, insert the two guide lugs of the cover into the recesses and press the cover until it clicks into place.

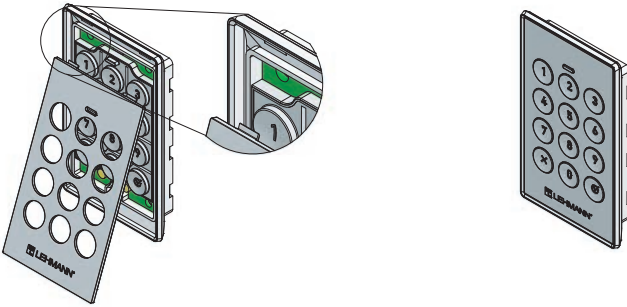

Installation instructions:

- Do not use countersunk head screws when installing the locker lock, the keypad and the striker plate.
- Flat headed screws (3,0 x 15 mm) are recommended for mounting the striker plate (only included in single-set packaging).
- A splash water and dust protection can only be ensured if the lock and the keypad lie completely on the door surface (except Omega-profiles).
- The locker lock M610 / M610 pro is available in two versions (right or left mounting).
- Please ensure the correct installation position of the lock and the keypad.
- Tighten the screws hand-tight.

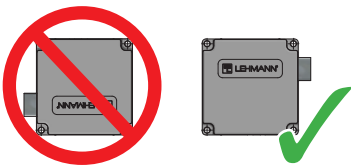

Right mounting (front view)

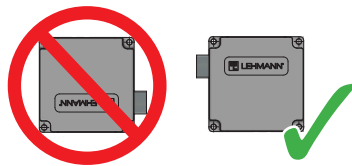

Left mounting (front view)

STRUCTURE OF THE KEYPAD TA03

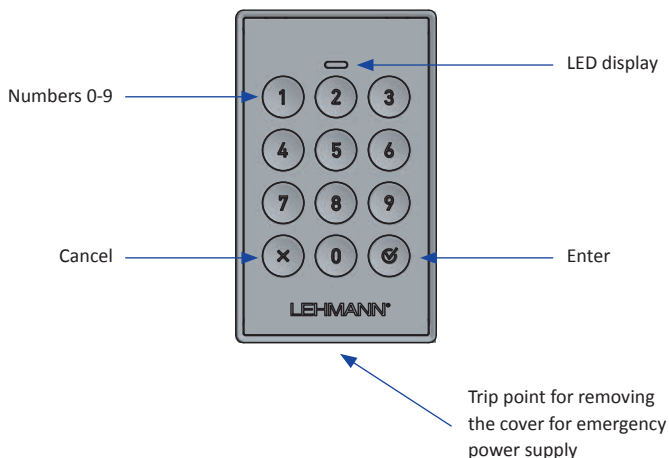

You can cancel any operation at any time by pressing the cancel button (X). When the cancel button is pressed, there is one short red flashing. Any input already made is deleted.

During operation, make sure that each key input is acknowledged by a light signal at the LED display! If a light signal does not appear, the key input was not accepted.

The optical signals are differentiated in colour and in duration as shown below:

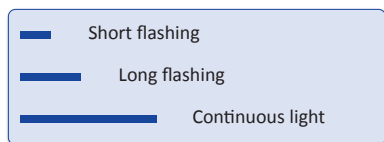

Note:

If no further key input is made during the entry of a code or during a programming operation, the already made entries will be discarded after 30 seconds. The old code remains valid.

After the third entry of an invalid code, the option to enter a code is blocked for 30 seconds. The display flashes red nine times. When a key is pressed during these 30 seconds, the LED display flashes red once.

PLAUSIBILITY CHECK OF BOLT END POSITION

The locking system has a plausibility check of the bolt end position. If the value is not within the expected range when closing, the LED display flashes red for four times. The lock is not locked. Check the correct mounting position of the lock and the striker plate.

FACTORY SETTINGS

The following settings apply for the locking system as delivered from the factory:

- Free Code mode
- The lock is in open position
- Master code: 9-0-8-0-7-0-5-5-5-5
- Emergency opening code: 1-0-1-0-5
- Acoustic signals are deactivated
- Automatic locking is deactivated
- Automatic opening is deactivated

ATTENTION: It is highly recommended to change the factory set master code and factory set emergency opening code!

OPENING & CLOSING IN FREE CODE MODE

The lock must be in open position.

To close, you can enter any 3 to 10 digit code. When entering, make sure that each key input is acknowledged by a light signal at the LED display.

Close (example: 1-4-5-6)

Keys ① ④ ⑤ ⑥ ✓
Display ■■■■■■■■

Lock closes.

Open (example: 1-4-5-6)

Keys ① ④ ⑤ ⑥ ✓
Display ■■■■■■

Lock opens.

After opening by entering the correct code, the previous code will be deleted. The lock can now be closed again with any 3 to 10 digit code.

If an invalid code is entered, the LED display flashes red three times.

SWITCHING TO FIXED CODE MODE

The lock must be in open position. There must be no battery warning.

The fixed code must be 3 to 10 digits.

If you have already changed the default master code, enter your valid master code here. In order to confirm the master code, press the keys **X** + **✓** simultaneously.

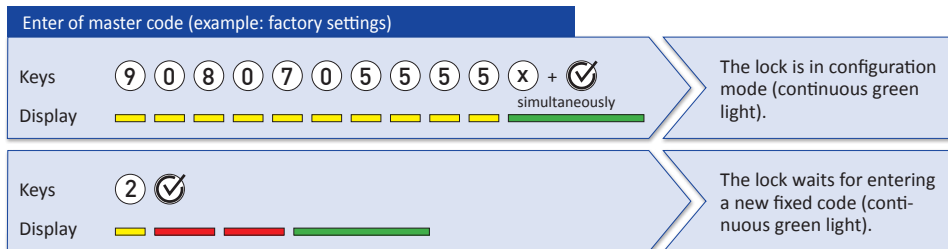

The LED display first flashes red twice after pressing the enter button and then turns to a continuous green light until a new fixed code has been entered.

Now enter your new personal fixed code immediately. When entering, make sure that the LED display acknowledges each key input.



If you cancel the enter process of a new fixed code with the cancel button or if you enter an incorrect code (invalid code length), the code 1-2-3 will automatically be valid. In this case the LED display flashes red ten times.

Check that the code has been accepted correctly with an open cabinet door.

Switching to Fixed Code mode deactivates the function „Automatic opening in Free Code mode“ or „Automatic closing in Fixed Code mode“ which may have been activated before.

OPENING & CLOSING IN FIXED CODE MODE

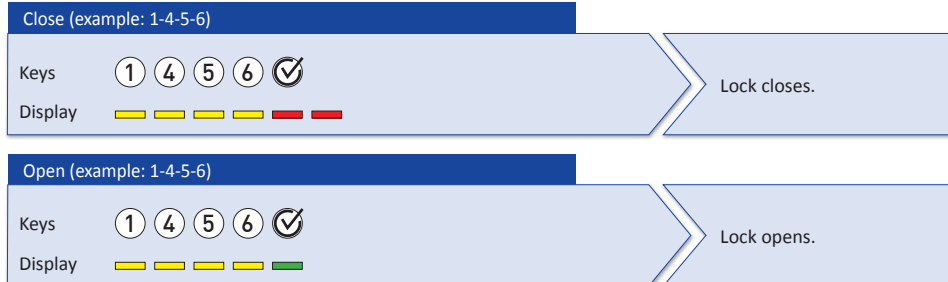

If an invalid code is entered, the LED display flashes red three times.

USER CHANGES THE FIXED CODE

The lock must be in open position. There must be no battery warning.

The fixed code must be 3 to 10 digits.

If you have already changed the default fixed code for the user, enter your valid code here.

The previous code will be overwritten by entering the new code.

Enter of valid fixed code (example: 1-4-5-6)

Keys 1 4 5 6 X + ✓
Display — — — — simultaneously

The lock waits for entering a new fixed code (continuous green light).

After the buttons X + ✓ are pressed simultaneously the LED will turn to a continuous green light until a new fixed code is entered.

Now enter your new personal fixed code immediately. When entering, make sure that the LED display acknowledges each key input.

Enter of new fixed code (example: 1-2-3-4-5)

Keys 1 2 3 4 5 ✓
Display — — — — —

When the LED display turns off, the new fixed code is valid.

If the new code is not entered correctly, the previous code remains valid. In this case, the LED display flashes red ten times.

Check with the open cabinet, that the new fixed code has been accepted correctly (see page 12, „Opening & closing in Fixed Code mode“).

SWITCHING TO FREE CODE MODE

The lock must be in open position. There must be no battery warning.

If you have already changed the default master code, enter your valid master code here. In order to confirm the master code, press the keys X + ✓ simultaneously.

Enter of master code (example: factory settings)

Keys 9 0 8 0 7 0 5 5 5 5 X + ✓
Display — — — — — — — — — simultaneously

The lock is in configuration mode (continuous green light).

Keys 1 ✓
Display — —

When the LED display turns off, Free Code mode is activated.

After you have successfully switched to Free Code mode, you can operate the lock with any random code (3 to 10 digits). Please refer to page 11, „Opening & closing in Free Code mode“.

Switching to Free Code mode deactivates the function „Automatic closing in Fixed Code mode“ or „Automatic opening in Free Code mode“ which... may have been activated before.

CHANGING THE MASTER CODE

It is highly recommended that you change the default master code and to choose the longest possible and secure master code.

The lock must be in open position. There must be no battery warning.

The master code must be 3 to 10 digits.

If you have already changed the default master code, enter your valid master code here. In order to confirm the master code, press the keys **X** + **✓** simultaneously.

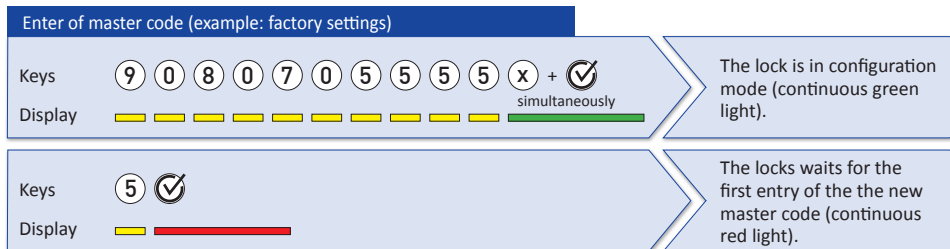

After the enter button is pressed the LED display will turn to a continuous red light until a new master code has been entered for the first time

Now carefully enter the new master code 2x in succession (as described in the following). When entering the new master code, make particularly sure that the LED display acknowledges each key input.

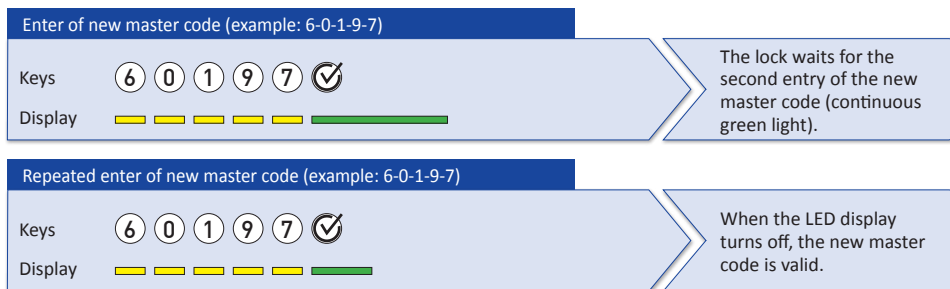

If the new master code has been entered correctly twice, there is a long green flashing in the LED display. The new master code is valid. In all other cases, the LED display flashes red ten times. The new master code was not accepted. The previous master code is still valid.

Perform immediately a functional test with the new master code!

CHANGING THE EMERGENCY OPENING CODE

It is highly recommended that you change the default emergency opening code and to choose the longest possible and secure emergency opening code.

The lock must be in open position. There must be no battery warning.

The emergency opening code must be 3 to 10 digits

If you have already changed the default master code, enter your valid master code here. In order to confirm the master code, press the keys **X** + **✓** simultaneously.

Enter of master code (example: factory settings)

Keys 9 0 8 0 7 0 5 5 5 5 **X** + **✓**
Display 

The lock is in configuration mode (continuous green light).

Keys 4 **✓**
Display 

The lock waits for the first entry of the new emergency opening code (continuous red light).

After the enter button is pressed the LED display will turn to a continuous red light until a new emergency opening code has been entered for the first time.

Now carefully enter the new emergency opening code 2x in succession (as described in the following). When entering the new emergency opening code, make particularly sure that the LED display acknowledges each key input.

Enter of new emergency opening code (example: 1-2-3-0-0)

Keys 1 2 3 0 0 **✓**
Display 

The lock waits for the second entry of the new emergency opening code (continuous green light).

Repeated enter of new emergency opening code (example: 1-2-3-0-0)

Keys 1 2 3 0 0 **✓**
Display 

When the LED display turns off, the new emergency opening code is valid.

If the new emergency opening code has been entered correctly twice, there is a long green flashing in the LED display. The new emergency opening code is valid. In all other cases, the LED display flashes red ten times. The new emergency opening code was not accepted. The previous emergency opening code is still valid.

Perform immediately a functional test with the new emergency opening code!

EMERGENCY OPENING

If you have already changed the default emergency opening code, enter your valid emergency opening code here.

Enter emergency opening code (example: Werkseinstellung)

Keys 1 0 1 0 5 ✓

Display 

Lock opens.

After an emergency opening in the Fixed Code mode, the lock can be used again normally with the previously programmed fixed code. If you want to change the fixed code, follow the instructions in section „User changes the Fixed code“ or in section “Switching to Fixed Code mode”.

After an emergency opening in the Free Code mode, the lock can be used normally again (see page 11, „Opening & closing in Free Code mode“).

If an invalid emergency opening code is entered, the LED display flashes red three times.

RESET TO FACTORY SETTINGS

If the reset to factory settings is carried out, all stored fixed code, master code, emergency opening code and settings will be deleted.

The lock must be in open position. There must be no battery warning. If necessary, perform an emergency opening to open the lock.

If you have already changed the default master code, enter your valid master code here. In order to confirm the master code, press the keys **X** + **✓** simultaneously.

Enter of master code (example: factory settings)

Keys 9 0 8 0 7 0 5 5 5 5 **X** + **✓**
simultaneously

Display 

The lock is in configuration mode (continuous green light).

Keys 0 ✓

Display 

When the LED display turns off, the reset to factory settings is completed.

AUTOMATIC LOCKING IN FIXED CODE MODE

The lock must be in open position. There must be no battery warning. This feature can only be activated in Fixed Code mode. If you have already changed the default master code, enter your valid master code here. In order to confirm the master code, press the keys **X** + **✓** simultaneously.

Enter of master code (example: factory settings)

Keys 9 0 8 0 7 0 5 5 5 5 X + ✓
 Display

The lock is in configuration mode (continuous green light).

Keys 6 ✓
 Display

The lock waits for the selection of the time span (continuous red light).

Select the time span after which the lock is to close automatically.

Selection of time spans

Automatic closing

Keys 0 ✓
 Display

Switches off

Keys 1 ✓
 Display

after 10 seconds

Keys 2 ✓
 Display

after 30 seconds

Keys 3 ✓
 Display

after 1 minute

Keys 4 ✓
 Display

after 5 minutes

Keys 5 ✓
 Display

after 15 minutes

Keys 6 ✓
 Display

after 1 hour

Keys 7 ✓
 Display

after 6 hours

Keys 8 ✓
 Display

after 12 hours

Keys 9 ✓
 Display

after 24 hours

Note that there may be slight variations in the time span. A second-exact measurement is not possible. When switching to the Free Code mode, this function is automatically deactivated.

AUTOMATIC OPENING IN FREE CODE MODE

The lock must be in open position. There must be no battery warning. This feature can only be activated in Free Code mode. If you have already changed the default master code, enter your valid master code here. In order to confirm the master code, press the keys (X) + (✓) simultaneously.

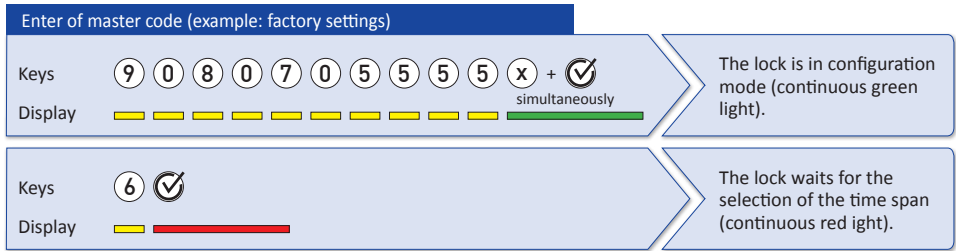

Select the time span after which the lock is to open automatically.



Note that there may be slight variations in the time span. A second-exact measurement is not possible. When switching to the Fixed Code mode, this function is automatically deactivated.

ACTIVATION AND DEACTIVATION OF ACOUSTIC SIGNALS

The lock must be in open position. There must be no battery warning.

Please note: The acoustic signals are done by the lock inside the furniture and not by the keypad on the outside of the furniture. In a noisy environment, the acoustic signals may not be heard.

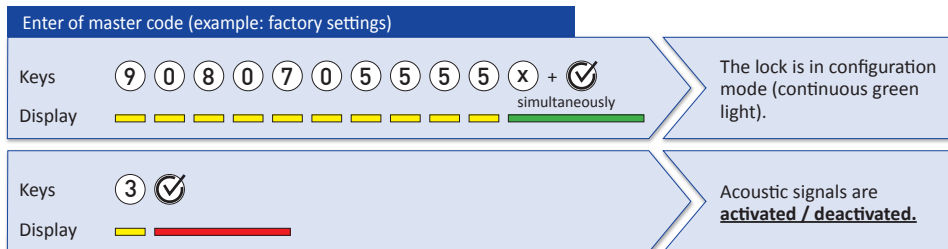





CONFIGURATION OF M610 TA03 PRO WITH NFC-APP

The lock M610 TA03 pro can be configured either manually or with the LEHMANN Config app. After putting the app into operation on an Android smartphone or Apple iPhone, configuration changes can be made via the app.

After starting the app, select “PIN Code” in the lower left area of the display. Once selected, the icon will be white and clearly visible. The fingerprint symbol on the right side of the display is nearly hidden.

Three functions are available in the upper display area:

<p>Profile</p>	<p>This function can be used to create and save configuration profiles on the smartphone. Configuration profiles that have already been created are displayed here. To create a profile, click on “Create new profile”. Assign a unique name for the configuration profile. Enter the desired configuration in the appropriate fields. Make sure to enter the valid master code at the end of the input mask. Finally, click on the Save button .</p> <p>To make changes to a configuration profile, select the configuration profile by briefly clicking on the name of the configuration profile in the overview. Enter the desired changes and click the Save button .</p> <p>If changes have been entered but you do not want them to be saved, click the Back button .</p> <p>To return to the profile overview from a configuration profile, click the Back button .</p> <p>To transfer a configuration profile to the lock, select the configuration profile, check the current master code and click Transfer. Hold the NFC antenna of the smartphone in front of the NFC antenna on the lock (see Data transfer to a keypad lock).</p> <p>To delete a configuration profile, press and hold on the name of the configuration profile in the overview of profiles. The delete symbol appears to the right of the profile .</p> <p>ATTENTION: If the master code was changed in the configuration profile at “New Master Code” and transferred to the lock, then this new master code must be entered in the configuration profile at “Current Master Code” for future configuration changes.</p>
<p>Manual Configuration</p>	<p>This feature allows configuration changes to be made without saving a configuration profile. Configuration changes are entered in the appropriate fields. To transfer the configuration to the lock, check the current master code and click “Transfer”. Hold the NFC antenna of the smartphone in front of the NFC antenna on the lock (see Data transfer to a keypad lock).</p>

Direct	With this function the “Reset” can be selected. The lock is set to the factory delivery mode. Select “Reset” and enter the current master code. To transmit the reset command to the lock, click “Transfer”. Hold the NFC antenna of the smartphone in front of the NFC antenna on the lock (see Data transfer to a keypad lock).
---------------	-----------------------------------------------------------------------------------------------------------------------------------------------------------------------------------------------------------------------------------------------------------------------------------------------------------------------------------

Data transfer to a keypad lock:

To transfer configurations or direct commands to the lock, first check the position of the NFC antenna on your smartphone. Activate the NFC interface on your smartphone.

Click on the „Transfer“ button in the LEHMANN Config App.

Hold the NFC antenna of your smartphone at the marked location on the corresponding lock. The NFC antenna in the lock is located in this area.

M610 pro

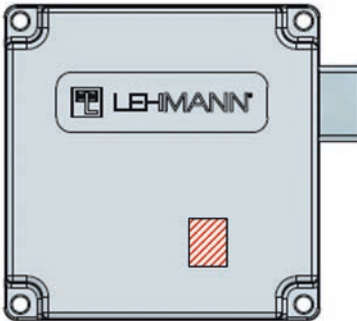

After a successful data transfer, a tick appears in the app.

BATTERY WARNING

The locking system is equipped with two battery warning levels (see table below).:

Warning level	LED-Display	Meaning
Stage 1		The batteries are weak and should be changed. Opening and closing of the lock are possible. Configuration changes are not possible.
Stage 2		The batteries are exhausted and must be changed immediately! The lock can only be opened. Configuration changes are not possible.

For changing the batteries see page 6 „Getting started & changing batteries“.

FIRMWARE UPDATE

You have the option of updating the firmware of the locking system via the micro USB port on the lock. Firmware updates are provided only when needed (for example, technical need). To update the firmware you need the software LEHMANN Firmware Updater. The software can be found on the website www.lehmann-locks.com under Electronic Locking Systems and there under Software Solutions. The individual steps for updating the firmware are described in the software.



DISPOSAL

Dispose of the locking system according to local regulations and guidelines. Remove the battery and dispose of the battery separately according to local regulations. When disposing of partially discharged batteries, make sure that there are no short circuits between the poles of the batteries (risk of explosion and fire).

LEHMANN Vertriebsgesellschaft mbH & Co. KG
Postfach 26 20 • D-32383 Minden
Fon +49 571/50 599-0 • Fax +49 571/50 599-822
info@lehmann-locks.com • www.lehmann-locks.com
DIN EN ISO 9001:2015 zertifiziert